

|          |  |
|----------|--|
| PROJECT  |  |
| TYPE     |  |
| NOTES    |  |
| QUANTITY |  |
| DATE     |  |

## YPSILON SURFACE

### D83309-WHI

#### GENERAL

Series: Ypsilon  
 Brand: Panzeri  
 Division: Design  
 Mounting Type: Surface  
 Mounting Location: Wall  
 Subcategory: Uplight

#### PHYSICAL

Shape: Rectangle  
 Length (mm): 145  
 Length (in): 5 <sup>11</sup>/<sub>16</sub>  
 Width (mm): 30  
 Width (in): 1 <sup>3</sup>/<sub>16</sub>  
 Height (mm): 620  
 Height (in): 24 <sup>7</sup>/<sub>16</sub>  
 Light Distribution: Indirect  
 Weight (kg): 1.015  
 Weight (lbs): 2.24  
 Diffuser: Extruded polycarbonate - opal  
 Fixture Material: Metal

#### ELECTRICAL

Input Wattage Range: 10 - 19 W  
 Lamp Type: LED  
 Input Wattage (W): 13  
 Total Output Wattage (W): 11  
 Dimming: Non-Dimmable  
 Driver Included: Yes  
 Driver Location: Integrated  
 Driver Type: Constant Current - 120Vac  
 Driver Class: Class 2  
 Input Voltage (V): 120 - 277  
 Constant Current (mA): 700  
 Upon Request: (Not included, see components) Remote:0-10Vdc dimming / 277Vac / (Included) Integral: Phase dimming

#### LED

Color Temperature (°K): 3000  
 Max. Delivered Lumen (lm): 1118  
 Nominal Lumen (lm): 1460  
 CRI: >80 CRI  
 Efficiency (%): 76.575  
 Lamp Life (hrs): 50000

#### OPTICAL

#### RATINGS AND CERTIFICATIONS

Certified By: CSA Certified to UL and CSA Standards  
 IP rating: IP20

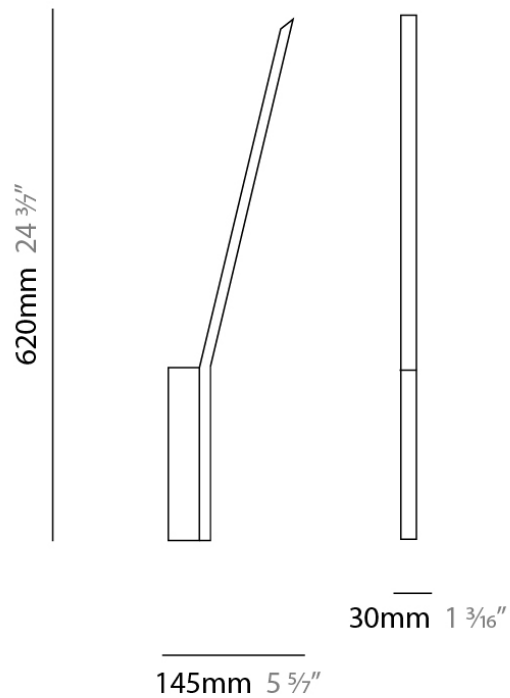

## YPSILON RECESSED

### D83320-WHI

|          |  |
|----------|--|
| PROJECT  |  |
| TYPE     |  |
| NOTES    |  |
| QUANTITY |  |
| DATE     |  |

#### GENERAL

Series: Ypsilon  
 Brand: Panzeri  
 Division: Design  
 Mounting Type: Recessed  
 Mounting Location: Wall  
 Subcategory: Wall Effect

#### PHYSICAL

Shape: Rectangle  
 Width (mm): 30  
 Width (in): 1  $\frac{3}{16}$ "  
 Height (mm): 620  
 Depth (mm): 40  
 Height (in): 24  $\frac{7}{16}$ "  
 Depth (in): 1  $\frac{9}{16}$ "  
 Extension (mm): 110  
 Extension (in): 4  $\frac{5}{16}$ "  
 Light Distribution: Indirect  
 Weight (kg): 0.975  
 Weight (lbs): 2.15  
 Fixture Material: Metal

#### ELECTRICAL

Input Wattage Range: 10 - 19 W  
 Lamp Type: LED  
 Input Wattage (W): 13  
 Total Output Wattage (W): 11  
 Dimming: Non-Dimmable  
 Driver Included: Yes  
 Driver Location: Integrated  
 Driver Type: Constant Current  
 Driver Class: Class 2  
 Input Voltage (V): 120  
 Constant Current (mA): 700  
 Upon Request: (Not included, see components) Remote:0-10Vdc dimming / 277Vac / (Included) Integral: Phase dimming

#### LED

Color Temperature (°K): 3000  
 Max. Delivered Lumen (lm): 1118  
 Nominal Lumen (lm): 1200  
 CRI: >80 CRI  
 Lamp Life (hrs): 50000







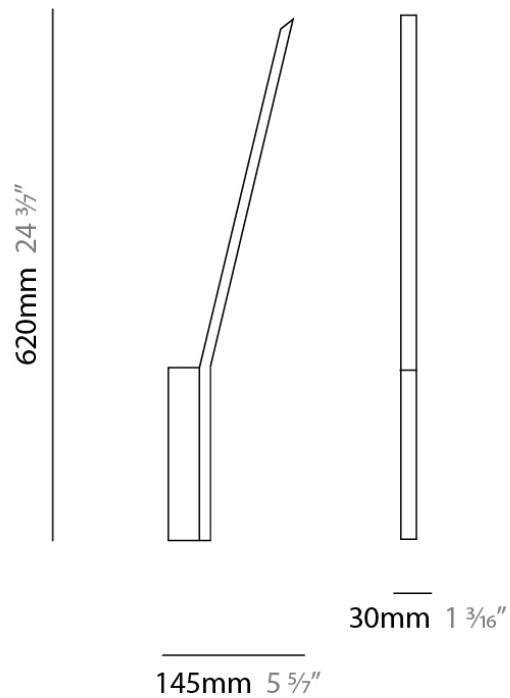
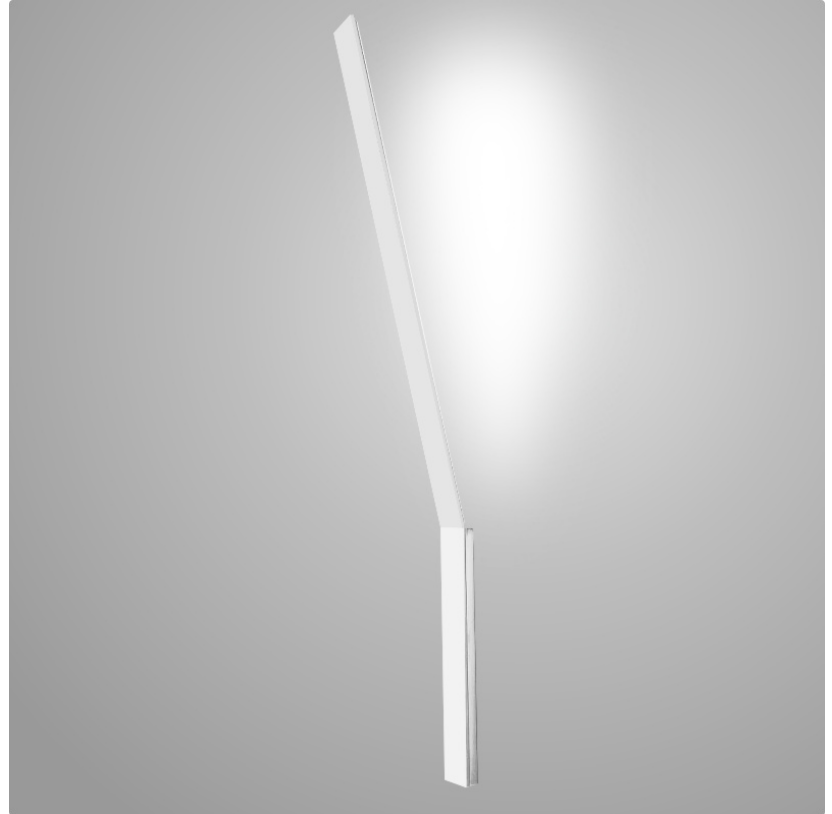





























































#### OPTICAL

#### RATINGS AND CERTIFICATIONS











Certified By: CSA Certified to UL and CSA Standards  
 IP rating: IP20













## LEGEND

|                                                                                    |                                                           |                                                                                     |                                                              |                                                                                       |                                                                                                |
|------------------------------------------------------------------------------------|-----------------------------------------------------------|-------------------------------------------------------------------------------------|--------------------------------------------------------------|---------------------------------------------------------------------------------------|------------------------------------------------------------------------------------------------|
|    | floor-mounted                                             |    | pivotal                                                      |    | special LED (upon request) RGB, RGBW, tunable, gold+, meat+, art+, fashion+                    |
|    | wall and ceiling: recessed and surface mounted            |    | rotating                                                     |    | warm dim / natural dimming LED                                                                 |
|    | ceiling-mounted and wall-mounted                          |    | illuminate tilted                                            |    | rechargeable battery powered                                                                   |
|    | wall-mounted                                              |    | color of suspension cable                                    |    | fixture with natural vivid LED (upon request)                                                  |
|    | omni-directional light distribution                       |    | length of suspension cable                                   |    | color rendering index                                                                          |
|    | direct light distribution                                 |    | reflector degree selection                                   |    | color temperature                                                                              |
|    | direct/indirect light distribution                        |    | super spot                                                   |    | lumen (luminous flux)                                                                          |
|    | indirect light distribution                               |    | lens                                                         |    | efficacy (lumens per watt)                                                                     |
|    | asymmetric light distribution                             |    | lens pack                                                    |    | Unified Glare Rating (UGR) range from 5-40                                                     |
|    | aura light distribution                                   |    | shine ring                                                   |    | marine grade (AISI 316 stainless steel)                                                        |
|    | round wall or ceiling cut-out                             |    | integrated shine ring with diffuser                          |    | walk on                                                                                        |
|    | square wall or ceiling cut-out                            |    | free individual colors 01-29                                 |    | drive on                                                                                       |
|   | the supplied jig specifies the cutout dimensions          |   | individual colors: 00 (free of charge), 01-25 (extra charge) |   | Dark Sky Compliance                                                                            |
|  | minimum distance (meters) lamp - object                   |  | luminaire part to be colored (F1)                            |  | Americans with Disabilities Act (less than 4" off the wall located between 27"-84" from floor) |
|  | recessed depth                                            |  | luminaire part to be colored (F2)                            |  | lamp protected against explosion                                                               |
|  | ceiling thickness in mm                                   |  | luminaire part to be colored (F3)                            |  | blown glass using traditional methods by master glass blower                                   |
|  | ceiling thickness selection                               |  | luminaire part to be colored (F4)                            |  | acoustic material                                                                              |
|  | dimmable DP (phase), DV (0-10V), DD (dali), DS (step-dim) |  | luminaire part to be colored (F5)                            |  | protection class I, protection insulation                                                      |
|  | included or excluded LED driver/transformer/control gear  |  | color of 3-circuit adaptor                                   |  | protection class II, protection insulation                                                     |
|  | separately switchable                                     |  | indirect diffuser                                            |  | ETL Certified to UL and CSA Standards                                                          |
|  | sensor                                                    |  | direct diffuser                                              |  | UL Certified to UL and CSA Standards                                                           |
|  | remote control                                            |  | ball-proof (upon request)                                    |  | CSA Certified to UL and CSA Standards                                                          |
|  | available upon request                                    |  | accessory                                                    |  | Certified for North American Standards                                                         |

## IP RATING

|                                                                                   |                                                                                                                                                  |
|-----------------------------------------------------------------------------------|--------------------------------------------------------------------------------------------------------------------------------------------------|
|  | protected against ingress of solid bodies greater than 12.5mm (finger)                                                                           |
|  | protected against ingress of solid bodies greater than 2.5mm<br>protected against sprays of water up to 60 degrees from the vertical (rain)      |
|  | protected against ingress of solid bodies greater than 1mm (wire)<br>no protection against the ingress of moisture                               |
|  | protected against ingress of solid bodies greater than 1mm (wire)<br>protected against sprays of water up to 60 degrees from the vertical (rain) |
|  | protected against ingress of solid bodies greater than 1mm (wire)<br>protected against water splashed from all directions                        |
|  | protected against limited ingress of dust (wet rooms/covered outdoor areas)<br>protected against water splashed from all directions              |
|  | protected against ingress of dust<br>protected against jets of water                                                                             |
|  | protected against ingress of dust<br>protected against powerful jets of water or heavy seas                                                      |
|  | protected against ingress of dust<br>protected against immersion of water between 15cm - 1m for 30 minutes                                       |
|  | protected against ingress of dust<br>protected against immersion of water under pressure for long periods                                        |

## IK RATING

|                                                                                     |                                                                                                       |
|-------------------------------------------------------------------------------------|-------------------------------------------------------------------------------------------------------|
|  | protected against 0.14 joules impact (equivalent to 0.25kg mass dropped from 56mm above the surface)  |
|  | protected against 0.2 joules impact (equivalent to 0.25kg mass dropped from 80mm above the surface)   |
|  | protected against 0.35 joules impact (equivalent to 0.25kg mass dropped from 140mm above the surface) |
|  | protected against 0.5 joules impact (equivalent to 0.25kg mass dropped from 200mm above the surface)  |
|  | protected against 0.7 joules impact (equivalent to 0.25kg mass dropped from 280mm above the surface)  |
|  | protected against 1 joules impact (equivalent to 0.25kg mass dropped from 400mm above the surface)    |
|  | protected against 2 joules impact (equivalent to 0.5kg mass dropped from 400mm above the surface)     |
|  | protected against 5 joules impact (equivalent to 1.7kg mass dropped from 300mm above the surface)     |
|  | protected against 10 joules impact (equivalent to 5.0kg mass dropped from 200mm above the surface)    |
|  | protected against 20 joules impact (equivalent to 5.0kg mass dropped from 400mm above the surface)    |